

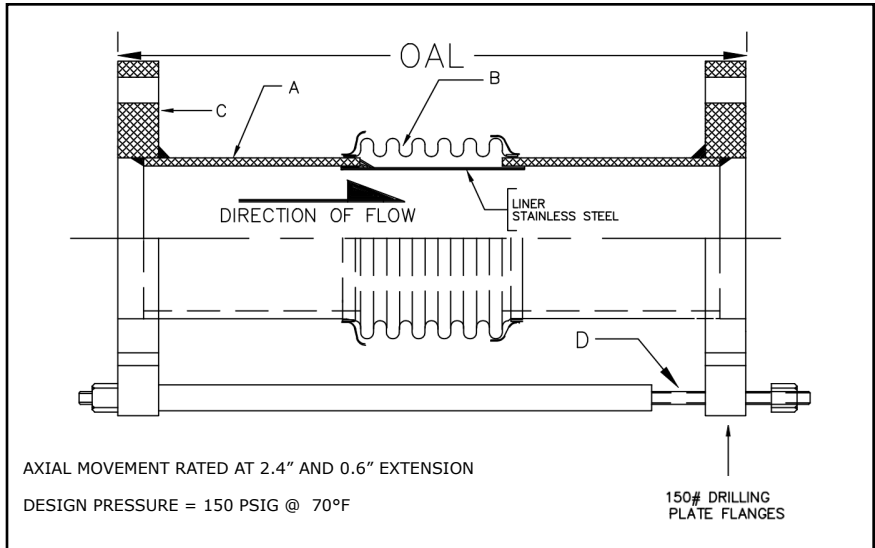









## 308 SERIES EXPANSION JOINT 3" TRAVEL W/150# PLATE FLANGES & TIE RODS

<b>PROJECT:</b>	
<b>CUSTOMER:</b>	
<b>ENGINEER:</b>	
<b>ARCHITECT:</b>	

MATERIALS OF CONSTRUCTION	
'A' PIPE SCH 40:	CARBON STEEL
'B' CAPSULE:	T-304 STN STL
'C' PLATE FLANGE:	CARBON STEEL
'D' TIE RODS/SPACERS	CARBON STEEL



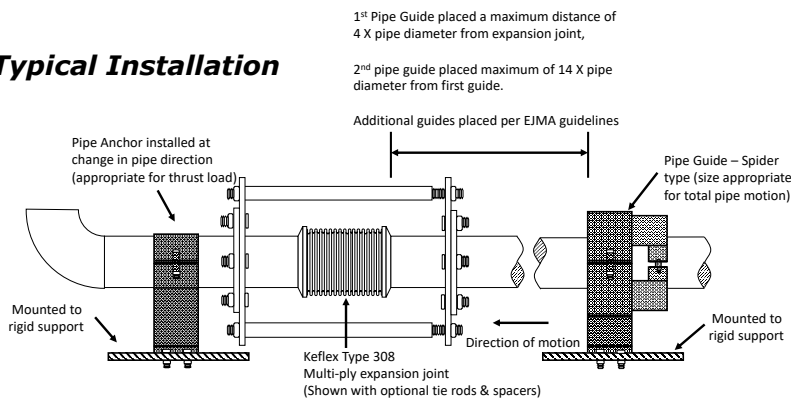

QTY	ID # OR TAG #	DIA (IN)	KEFLEX PART #	OAL	AXIAL FORCE TO COMPRESS (LBS)	WEIGHT (LBS)	3D Model (.stp)
		2"	F020M308T1503	17"	200	31	
		2 1/2"	F024M308T1503	17"	400	36	
		3"	F030M308T1503	17"	300	41	
		4"	F040M308T1503	17"	700	50	
		5"	F050M308T1503	17"	425	66	
		6"	F060M308T1503	17"	500	78	
		8"	F080M308T1503	17"	750	120	
		10"	F100M308T1503	17"	1000	158	
		12"	F120M308T1503	17"	600	211	

### Typical Installation



### IMPORTANT LINKS

BROCHURE:	
INSTALLATION INSTRUCTIONS:	
TECHNICAL DATA:	
WEBSITE:	<a href="http://FLEX-WELD.COM">FLEX-WELD.COM</a>



MADE IN THE USA

1425 LAKE AVE  
WOODSTOCK, IL 60098  
815-334-3600