



HVAC Products

# SUBMITTAL

Mar 2018

## 308 SERIES EXPANSION JOINT 2" TRAVEL W/WELD ENDS & TIE RODS

<b>PROJECT:</b>	
<b>CUSTOMER:</b>	
<b>ENGINEER:</b>	
<b>ARCHITECT:</b>	

MATERIALS OF CONSTRUCTION	
'A' PIPE SCH 40:	CARBON STEEL
'B' CAPSULE:	T-304 STN STL
'C' PLATE FLANGE:	CARBON STEEL
'D' TIE RODS/SPACERS	CARBON STEEL

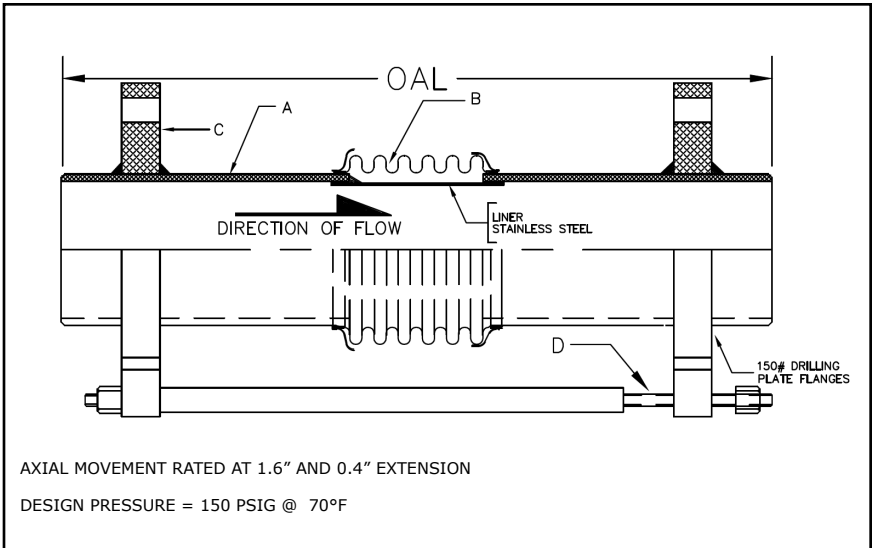

QTY	ID # OR TAG #	DIA (IN)	KEFLEX PART #	OAL	AXIAL FORCE TO COMPRESS (LBS)	WEIGHT (LBS)	3D Model (.stp)
		2"	F020M308T902	15"	175	28	
		2 1/2"	F024M308T902	15"	350	33	
		3"	F030M308T902	15"	225	38	
		4"	F040M308T902	15"	575	46	
		5"	F050M308T902	15"	350	60	
		6"	F060M308T902	15"	400	74	
		8"	F080M308T902	15"	575	111	
		10"	F100M308T902	15"	850	147	
		12"	F120M308T902	15"	475	199	

### Typical Installation

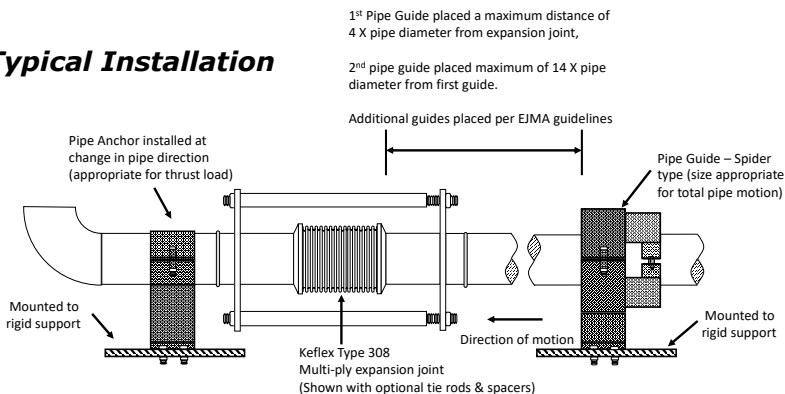

### IMPORTANT LINKS

BROCHURE:	
INSTALLATION INSTRUCTIONS:	
TECHNICAL DATA:	
WEBSITE:	<a href="http://KELCOIND.COM">KELCOIND.COM</a>



MADE IN THE USA

**1425 LAKE AVE  
WOODSTOCK, IL 60098  
815-334-3600**