

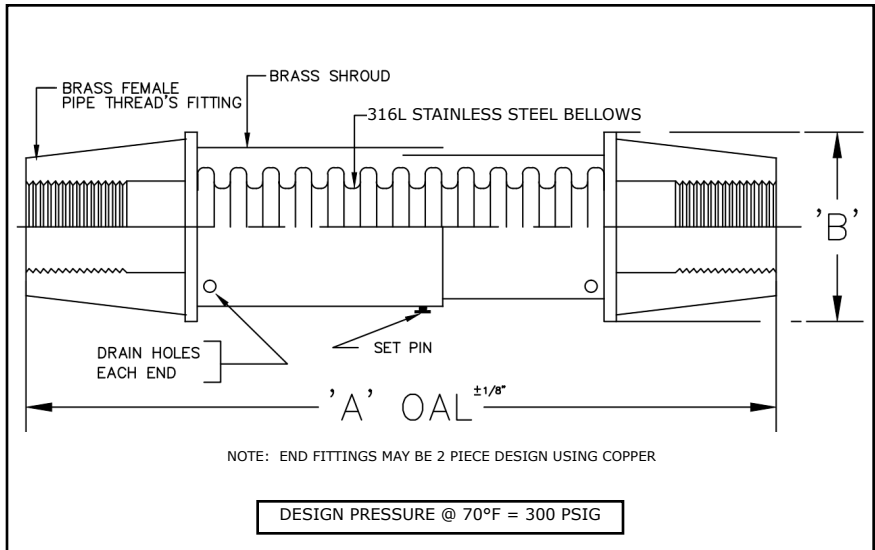







7Q SERIES QUADRA-SIDE EXPANSION COMPENSATOR W/FEMALE ENDS

| | |
|-------------------|--|
| PROJECT: | |
| CUSTOMER: | |
| ENGINEER: | |
| ARCHITECT: | |





| MATERIALS OF CONSTRUCTION | |
|---------------------------|----------------------|
| SHROUD: | BRASS |
| BELLOWS: | 316L STAINLESS STEEL |
| END FITTINGS: | BRASS |

| QTY | ID # OR TAG # | DIA (IN) | KEFLEX PART # | 'A' OAL | 'B' WIDTH (SQ.) | RATED STROKE | | WEIGHT (LBS) | 3D Model (.stp) |
|-----|---------------|----------|---------------|---------|-----------------|--------------|-----------|--------------|---|
| | | | | | | COMP. (IN) | EXT. (IN) | | |
| | | 3/4" | F0067Q | 6 1/2" | 2" | 1 1/2" | 1/2" | 2 1/4 |  |
| | | 1" | F0107Q | 6 1/2" | 2" | 1 1/2" | 1/2" | 2 1/4 |  |
| | | 1 1/4" | F0127Q | 6 1/2" | 2" | 1 1/2" | 1/2" | 2 1/2 |  |
| | | 1 1/2" | F0147Q | 6 1/2" | 2 1/2" | 1 1/2" | 1/2" | 4 |  |
| | | 2" | F0207Q | 6 1/2" | 3" | 1 1/2" | 1/2" | 5 3/4 |  |
| | | 2 1/2" | F0247Q | 7" | 3 1/2" | 1 1/2" | 1/2" | 7 3/4 |  |
| | | 3" | F0307Q | 7 3/4" | 4 1/2" | 1 1/2" | 1/2" | 11 |  |
| | | 4" | F0407Q | 8" | 5 1/2" | 1 1/2" | 1/2" | 12 |  |

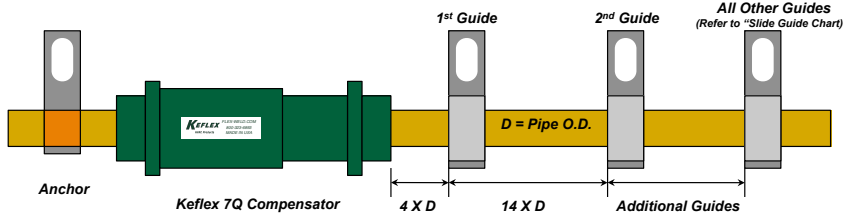
Typical Pipe Guide Installation



| IMPORTANT LINKS | |
|----------------------------|---|
| BROCHURE: |  |
| INSTALLATION INSTRUCTIONS: |  |
| TECHNICAL DATA: |  |
| WEBSITE: | KELCOIND.COM |



MADE IN THE USA

**1425 LAKE AVE
WOODSTOCK, IL 60098
Ph: 815-334-3600**