

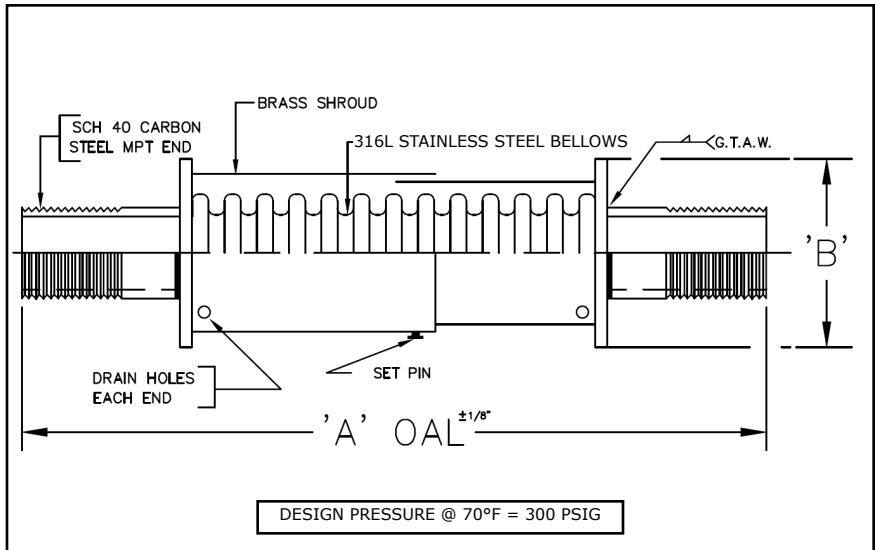







7Q SERIES QUADRA-SIDE EXPANSION COMPENSATOR W/MALE PIPE THREADS

PROJECT:	
CUSTOMER:	
ENGINEER:	
ARCHITECT:	





MATERIALS OF CONSTRUCTION	
SHROUD:	BRASS
BELLOWS:	316L STAINLESS STEEL
END FITTINGS:	CARBON STEEL

QTY	ID # OR TAG #	DIA (IN)	KEFLEX PART #	'A' OAL	'B' WIDTH (sq.)	RATED STROKE		WEIGHT (LBS)	3D Model (.stp)
						COMP. (IN)	EXT. (IN)		
		3/4"	F0067QMPT	9 1/2"	2"	1 1/2"	1/2"	2 1/2	
		1"	F0107QMPT	9 1/2"	2"	1 1/2"	1/2"	2 3/4	
		1 1/4"	F0127QMPT	9 1/2"	2"	1 1/2"	1/2"	3 1/4	
		1 1/2"	F0147QMPT	9 1/2"	2 1/2"	1 1/2"	1/2"	4	
		2"	F0207QMPT	9 1/2"	3"	1 1/2"	1/2"	5 1/4	
		2 1/2"	F0247QMPT	9 1/2"	3 1/2"	1 1/2"	1/2"	7 1/2	
		3"	F0307QMPT	9 1/2"	4 1/2"	1 1/2"	1/2"	9 1/2	
		4"	F0407QMPT	9 1/2"	5 1/2"	1 1/2"	1/2"	10 1/2	

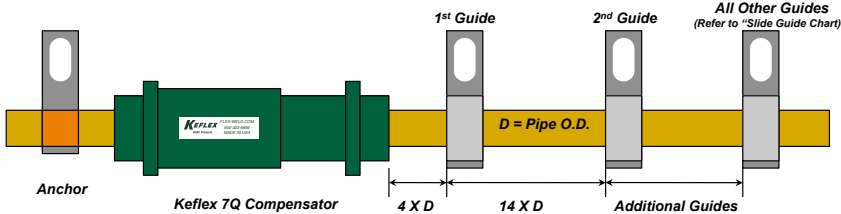
Typical Pipe Guide Installation



IMPORTANT LINKS

BROCHURE:	
INSTALLATION INSTRUCTIONS:	
TECHNICAL DATA:	
WEBSITE:	FLEX-WELD.COM



MADE IN THE USA

1425 LAKE AVE
WOODSTOCK, IL 60098
800-323-6893